

Tools Needed



5/8" (57 mm)

1

For Standard 3' and 4' Doors.

For installation with mullion and other backset requirements, add/subtract from dimensions shown.

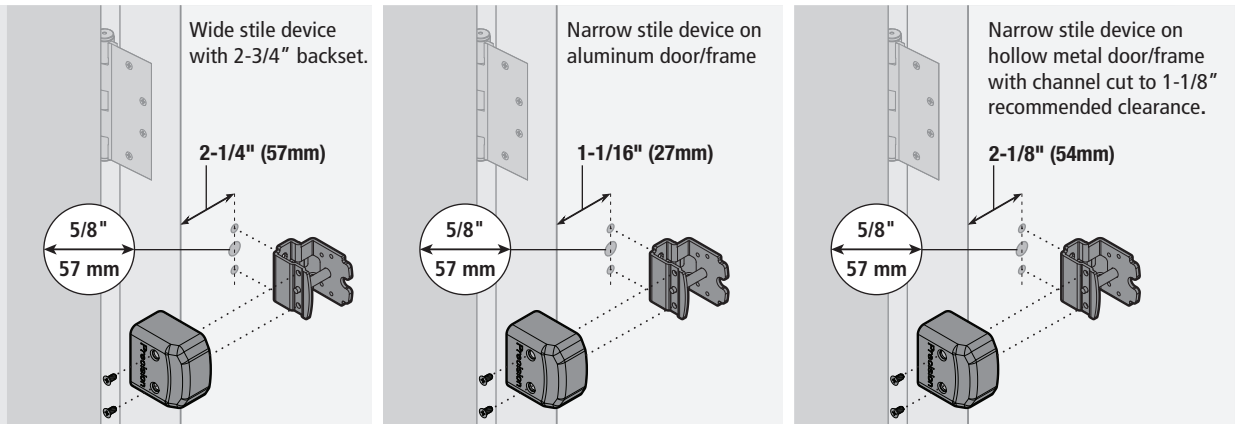

2

⚠️ Disconnect all power before servicing. Consult local codes to determine proper wiring.

Field wiring (by others)

Transfer device required (EPT, Electric Hinge, or Conduit)

For lock stile machining and mounting bracket location, see Device Template.

3

Operation: Normally Open Circuit across red and blue wires.

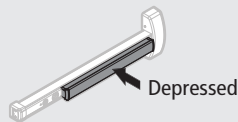
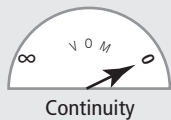
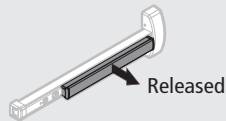
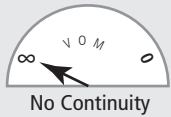

Operation: Normally Closed Circuit across violet and blue wires.

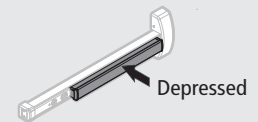
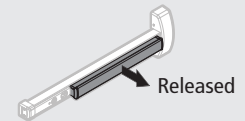

4

TS Switch wiring from hinge side of device.

Red
Normally Open
Blue
Common
Violet
Normally Closed

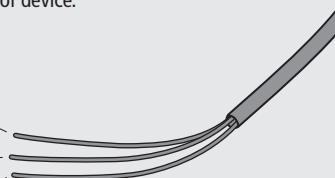

TDS Switch wiring from hinge side of device. (D.P.D.T. Option)

Red/White
Normally Open
Blue/White
Common
Violet/White
Normally Closed

Red
Normally Open
Blue
Common
Violet
Normally Closed

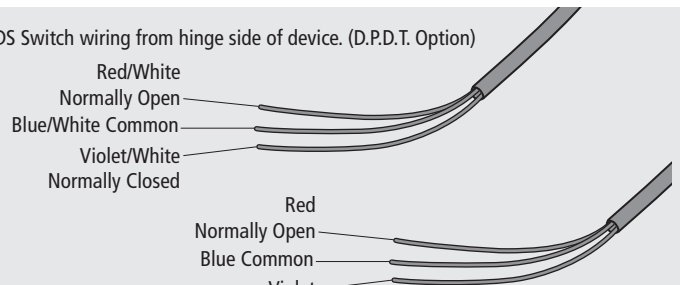

For assistance or warranty information:
Call 1-855-365-2407 or visit
www.stanleycommercialhardware.com

⚠ Warning: This Manufacturer advises that no lock can provide complete security by itself. This lock may be defeated by forcible or technical means, or evaded by entry elsewhere on the property. No lock can substitute for caution, awareness of your environment, and common sense. Builder's hardware is available in multiple performance grades to suit the application. In order to enhance security and reduce risk, you should consult a qualified locksmith or other security professional.

Pour de l'aide ou des informations sur la garantie:
Veuillez appeler le 1-855-365-2407 ou visiter
www.stanleycommercialhardware.com

⚠ Advertissement: Le fabricant tient à vous aviser qu'aucun verrou ne peut à lui seul offrir une sécurité complète. Ce verrou peut être mis hors d'état par la force ou des moyens techniques ou être évité par l'utilisation d'une autre entrée sur la propriété. Aucun verrou ne peut remplacer la surveillance de votre environnement et le bon sens. La quincaillerie pour le constructeur est offerte selon différents grades de performance pour différentes applications. Afin d'augmenter la sécurité et de réduire le risque, vous devriez consulter un serrurier qualifié ou un autre professionnel de la sécurité.

Si desea ayuda o información sobre la garantía:
llame al 1-855-365-2407 o visite
www.stanleycommercialhardware.com

⚠ Advertencia: Este Fabricante hace saber que no hay cerrojos que puedan proporcionar completa seguridad por sí mismos. Puede hacerse que falle este cerrojo forzándolo o utilizando medios técnicos, o puede evadirse entrando por otra parte de la propiedad. No hay cerrojos que puedan hacer de sustitutos para la precaución, el estar al tanto del entorno, y el sentido común. Pueden obtenerse piezas de ferretería de constructor con diversos grados de rendimiento para ajustarse a la aplicación. Para realizar la seguridad y reducir los riesgos, debe consultar con un cerrajero capacitado u otro profesional de seguridad.